



Johnsonite®

ACCESSORIES

Stairwell Management Solutions



THE ULTIMATE
FLOORING EXPERIENCE

Stairwell Management. It's good design. It's good business.

IT'S A KEY COMPONENT
OF OUR INTEGRATED
FLOORING SYSTEM.

While we have no doubt you're on your way to that corner office, we want to make sure you get there in one piece. Without tripping or slipping up or down the stairs. We know safety is a huge concern. Especially considering that slip/falls account for many disabling workplace injuries. So we created a complete and integrated stairwell management system. Let Johnsonite® keep your stair travel and your bottom line secure. Floor after floor.

Take inspiration
up a level.

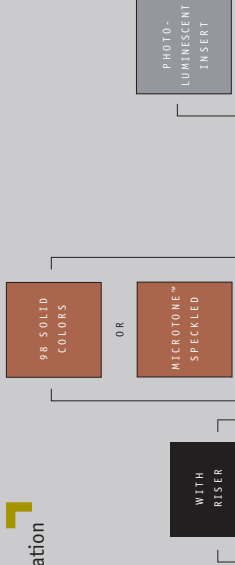

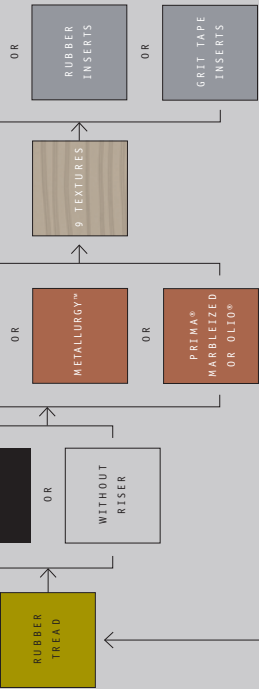

With the Johnsonite portfolio, you can design safe AND aesthetically satisfying stairwells. It starts with choices. Do you want rubber or vinyl? With or without risers? A solid color or a marble look?

Then there's an entire world of textures to explore. You can stop there or wrap it all up with rubber inserts or grit tape. Pick your preferences in the pages that follow and make "taking the stairs" a little more appealing.

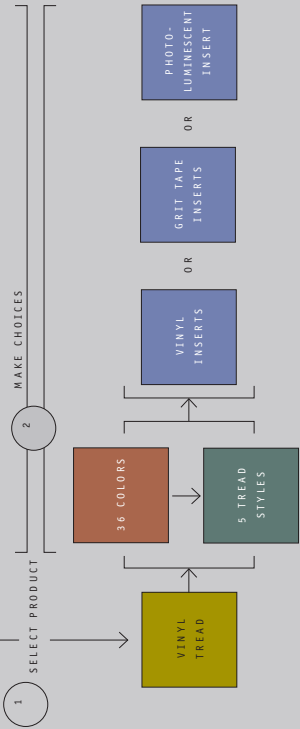

Rubber Stair Treads (without Riser)

Texture	Product Ordering Code for Insert			Lengths (See below)	Depths (See Pg 13)	Standard Palette**	Special Order**	Nose Depth
	No Insert	Grit Tape	Solid Color					
Raised Round	RH-RD	VIRH-RD	VIRHS-RD	Y	12 1/4"	A, B	Prima, SP	Sq. 2"
Raised Square	RH-SQ	VIRH-SQ	VIRHS-SQ	Y	12 1/4"	A, B, SP	Prima	Sq. 2"
Hammered	HMT	VIHMT	VIHMTS	Z	12 1/4"	A, B, SP, M	Prima	Sq. 2"
Hammered	HMTD	VIHMTD	VIHMTDS	Z	14"	A, B, SP, M	Prima	Sq. 2"
Diamond	CN	VICN	VICNS	X	13 1/4"	A, B, SP	Prima	Sq. 2", Rd. ***
Bamboo	BMT	VIBMT	VIBMTS	X	13 1/4"		A, B, Prima, SP	Sq. 2", Rd. ***
Cubis	CUT	VICUT	VICUTS	X	13 1/4"		A, B, Prima, SP	Sq. 2", Rd. ***
Fast Lane	CFLT	VICFLT	VICFLTS	X	13 1/4"		A, B, Prima, SP	Sq. 2", Rd. ***
Rice Paper	FRPAT	VIFRPAT	VIFRPATS	X	13 1/4"	A, B, SP	Prima	Sq. 2", Rd. ***
Service Weight Smooth	S	VIS	N/A	X	13 1/4"	A, B	-	Sq. 1 7/8"
Service Weight Safe-T Grip	-	SA*	N/A	X	13 1/4"	A, B	-	Sq. 1 5/8"

* 2-One inch strips

** A = Color Palette A

B = Color Palette B

SP = MicroTone Speckled Colorways

M = Metallurgy Colorways

*** Round nose is special order

SIZES/AVAILABLE LENGTHS

X = 3', 3.5', 4', 4.5', 5', 6'

Y = 3', 3.5', 4', 4.5', 5', 6', 7', 8'

Z = 3', 3.5', 4', 4.5', 5', 6', 7', 8', 9'

<p>Special Notes</p>	<ul style="list-style-type: none">● Prima Marbleized and Prima Olivo available by special order. Consult factory for details.● Most Johnsonite Treads have hinged square noses to accommodate pan steps.● In compliance with ADA recommendations, Johnsonite suggests that the riser and nosing portion of the stair tread should be bonded directly to the step surface in all tread or tread/riser combination installations. In order to minimize trip hazards, do not overlap the nosing over riser material.● Thickness .210" tapering to .113" (5.33mm to 2.87mm).
<p>How To Order:</p>	<ol style="list-style-type: none">1. Select Product Code – e.g., RH-RD For Raised Round Texture2. Select Color Code – e.g., RH-42-RD For 42 Beige Color3. Select Length – e.g., RH-42-RD-4' 4' For 4' Length4. Select Nose Style - e.g., RH-42-RD-4'-Sq Sq for Square Nose and Rd for Round Nose

Rubber Stair Treads with Integrated Riser

Texture	Product Ordering Code for Insert		Lengths (See below)	Depths (See Pg 13)	Standard Palette**	Special Order**	Nose Depth	
	No Insert	Grit Tape						Solid Color
Raised Round	RTR-RD	VIRTR-RD	VIRTRS-RD	Z	20"	A, B	Prima, SP	Sq. 2"
Raised Square	RTR-SQ	VIRTR-SQ	VIRTRS-SQ	Z	20"	A, B, SP	Prima	Sq. 2"
Hammered	HTR	VIHTR	VIHTRS	Z	20"	A, B, M, SP	Prima	Sq. 2"
Diamond	CNTR	VICNTR	VICNTRS	X	20"	A, B, SP	Prima	Sq. 2"
Bamboo	BMTR	VIBMTR	VIBMTRS	X	20"	A, B, SP	Prima	Sq. 2"
Cubis	CUTR	VICUTR	VICUTRS	X	20"	A, B	Prima, SP	Sq. 2"
Fast Lane	CFLTR	VICFLTR	VICFLTRS	X	20"	A, B	Prima, SP	Sq. 2"
Rice Paper	FRPATR	VIFRPATR	VIFRPATRS	X	20"	A, B, SP	Prima	Sq. 2"

** A = Color Palette A
 B = Color Palette B
 SP = MicroTone Speckled Colorways
 M = Metallurgy

SIZES/AVAILABLE LENGTHS

X = 3', 3.5', 4', 4.5', 5', 6'

Z = 3', 3.5', 4', 4.5', 5', 6', 7', 8', 9'

<p>Special Notes</p>	<ul style="list-style-type: none"> • Prima Marbleized and Prima Olivo available by special order. Consult factory for details. • Johnsonite Treads have hinged square noses to accommodate pan steps. • In compliance with ADA recommendations, Johnsonite suggests that the riser and nosing portion of the stair tread should be bonded directly to the step surface in all tread or tread/riser combination installations. In order to minimize trip hazards, do not overlap the nosing over riser material. • Thickness .210" tapering to .113" (5.33mm to 2.87mm).
<p>How To Order:</p>	<ol style="list-style-type: none"> 1. Select Product Code – e.g., RTR-RD 2. Select Color Code – e.g., RTR-42-RD 3. Select Length – e.g., 4' – RTR-42-RD-4' 4. Select Nose Style - e.g., RH-42-RD-4'-Sq <p>For Raised Round Texture For 42 Beige Color 4' For 4' Length Sq for Square Nose and Rd for Round Nose</p>

Rubber Stair Treads with Integrated Riser

**RUBBER TREAD WITH
INTEGRATED RISER**



Raised Round
Tread/Riser
(RTR-RD)

A B Z *

★



Raised Round
Tread/Riser
Visually Impaired
(VIRTR-RD)

A B Z *

★

**RUBBER TREAD WITH INTEGRATED
RISER FOR THE VISUALLY IMPAIRED**

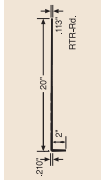

Raised Square
Tread/Riser
(RTR-SQ)

A B Z *

★



Raised Square
Tread/Riser
Visually Impaired
(VIRTR-SQ)

A B Z *

★

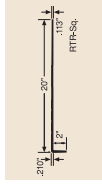

For enlarged textures, see page 15. See legend on page 14.



Hammered
Tread/Riser
(HTR)

A B M *

Z *



Hammered
Tread/Riser
Visually Impaired
(VIHTR)

A B M *

Z *



Bamboo
Tread/Riser
(BMTR)

A B X *



Bamboo
Tread/Riser
Visually Impaired
(VIBMTR)

A B X *

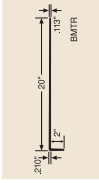

Rubber Stair Treads with Integrated Riser

RUBBER TREAD WITH INTEGRATED RISER



Cubis
Tread/Riser
(CUTR)

RUBBER TREAD WITH INTEGRATED RISER FOR THE VISUALLY IMPAIRED

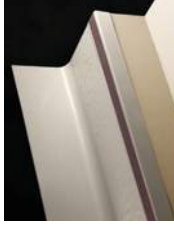

Cubis Tread/Riser
Visually Impaired
(VICUTR)

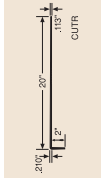

Fast Lane
Tread/Riser
(CFLTR)

Fast Lane Tread/
Riser
Visually Impaired
(VICFLTR)

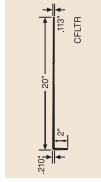

For enlarged textures, see page 15. See legend on page 14.



Diamond
Tread/Riser
(CNTR)

A B X *



Diamond
Tread/Riser
Visually Impaired
(VICNTR)

A B X *



Rice Paper
Tread/Riser
(FRPATR)

A B X *



Rice Paper
Tread/Riser
Visually Impaired
(VIFRPATR)

A B X *



Rubber Stair Treads without Integrated Riser

STANDARD RUBBER STAIR TREADS



Raised Round Tread (RH-RD)
 A B
 Y

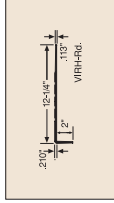

Raised Round Tread without Riser Visually Impaired (VIRH-RD)
 A B
 Y

STANDARD RUBBER STAIR TREADS FOR THE VISUALLY IMPAIRED



Raised Square Tread (RH-SQ)
 A B
 X

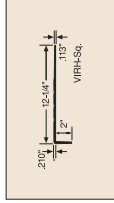

Raised Square Tread without Riser Visually Impaired (VIRH-SQ)
 A B
 X



Hammered Tread (HMT) 12 1/4" deep (HMTD) 14" deep
 A B
 Z

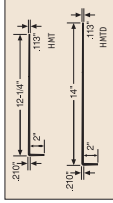

Hammered Tread without Riser Visually Impaired (VIHMT) 12 1/4" deep (VIHMTD) 14" deep
 A B

For enlarged textures, see page 15. See legend on page 14.

Service Weight
Smooth Tread
(S)

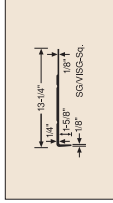

Service Weight
Smooth Tread
Visually Impaired
(VIS)



Heavy Duty
Diamond Tread
(CN)

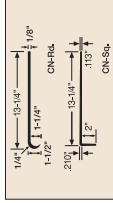

Heavy Duty Diamond Tread
Visually Impaired
(VICN)



Rice Paper Tread
(FRPT)

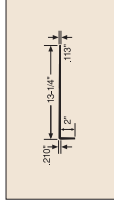

Rice Paper Tread
Visually Impaired
(VIFRPT)



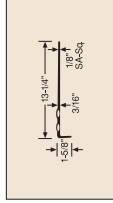

Service Weight
Safe-T-Grip Tread
(SA)



NSC Certified





COLOR PALETTE AVAILABILITY

- A** = See Color Palette A on pages 26-27 for details
- B** = See Color Palette B on pages 28-31 for details
-  = MicroTone™ Speckled colorways. See pages 32-35 for details.
- M** = Can be ordered in Metallurgy colorways. See page 31 for details.
-  = Can be special ordered in Prima® Marbleized and Prima Olio® colorways. Visit tarkettna.com. Minimums may apply.
-  = Can be special ordered in Speckled colorways. See page 32-35 for details.

STAIR TREAD INSERT COLOR COMBINATIONS

-  = See chart on pages 16-17 for recommended contrasting color combinations.

SIZES/AVAILABLE LENGTHS

-  = 3', 3.5', 4', 4.5', 5', 6'
-  = 3', 3.5', 4', 4.5', 5', 6', 7', 8'
-  = 3', 3.5', 4', 4.5', 5', 6', 7', 8', 9'
-  = Hinged nose for angled steps.

ENLARGED TEXTURES BELOW



INDOOR AIR QUALITY

Low Emitting materials EQ 4.3
FloorScore™ certified and meets CA 01350



RAISED ROUND



RAISED SQUARE



HAMMERED



BAMBOO



CUBIS



FAST LANE



DIAMOND









RICE PAPER



SMOOTH







VISUALLY IMPAIRED COLOR SOLUTIONS +

GRIT TAPE COLOR

	Black
	Brown
	Grey
	Tan
	Yellow
	White



Black: Grit tape contrasts with colors 01, 05, 12, 21, 24, 27, 28, 29, 31, 32, 38, 41, 48, 55, 58, 59, 62, 71, 75, 84, 106, 121, 129, 135, 138, 139, 150, 151, 163, 165, 166, 190, 192, 280, 281, 282, 289, 291, 293, 468, 470, 472, 476, 590, 591, 592, 593, AGM, BRL, BRM, CGL, CGM, CPM, WGL, WGM, LA2, LA3,

SOLID COLOR RUBBER INSERT

	40 Black
	47 Brown
	49 Beige
	55 Silver Grey
	75 Lemon
	85 Burgundy

40 Black: Insert contrasts with colors 01, 05, 12, 21, 24, 27, 28, 29, 31, 32, 38, 41, 48, 55, 58, 59, 62, 71, 75, 84, 106, 121, 129, 134, 135, 138, 139, 150, 151, 163, 165, 166, 190, 192, 280, 281, 282, 289, 291, 293, 468, 470, 472, 476, 486, 590, 591, 592, 593, AGM, BRL, BRM, CGL, CGM, CPM,

COLOR PALETTE AVAILABILITY

-  **A** = See color palette A on pages 26-27 for details.
-  **B** = See color palette B on pages 28-31 for details.
-  = Can be specially ordered in Prima Marbleized and Prima Olio colorways. Visit tarkettna.com. Minimums may apply.

LANDING TILE

All tiles available in 24" x 24".
Smooth is also available in 12" x 12".



Smooth (C)



Diamond (CN)



All tile textures can be used as landing tile.

LA5, LA6, LA8, LB4, LB6, LC8, LC1, LC2, LC3, LC4, LC5, LC6, LC7, LD1, LD2, LD4, LD5, LD7, LE1, LE3, LE7, LE2, LF6, LF8, LF9, LG1, LG3, LG8, LH3, LH7, LJ1, LJ2, LJ3, LJ5, LJ7, LJ8, LJ9, LK1, TB5, TB6

Brown: 09, 11, 19, 22, 33, 34, 42, 45, 49, 60, 68, 80, 111, 112, 130, 146, 165, 285, 286, 469, 473, 474, 475, LA1, LA9, LB2, LB3, LC9, LD8, LD9, LE2, LE4, LE5, LE8, LE9, LF1, LF3, LF4, LG4, LG7, LG9, LH2, LH4

Grey: 15, 18, 20, 40, 72, 73, 85, 86, 92, 148, 162, 168, 294, 471, CGD, LB5, LB8, LB9, LD3, LE6, LF5, LG2, LG6, LH7, LH9, WGD

Tan: 47, 63, 76, 101, 113, 132, 149, 167, 284, 287, 548, 725, BRD, CPD, LA7, LB1, LD6

Yellow: 70, LB7, LF7, LJ4

White Grit Tape available by special order

Photoluminescent Tape available

WGL, WGM, LA2, LA3, LA5, LA6, LA8, LB4, LB6, LC8, LC1, LC2, LC3, LC4, LC5, LC6, LC7, LD1, LD2, LD4, LD5, LD7, LE1, LE3, LE7, LE2, LF6, LF8, LF9, LG1, LG3, LG8, LH3, LH7, LJ1, LJ2, LJ3, LJ5, LJ7, LJ8, LJ9, LK1, TB5, TB6

47 Brown: 09, 11, 19, 22, 33, 34, 42, 45, 49, 68, 80, 111, 112, 130, 146, 165, 285, 286, 469, 473, 474, 475, LA1, LA9, LB2, LB3, LC9, LD8, LD9, LE2, LE4, LE5, LE8, LE9, LF1, LF3, LF4, LG4, LG7, LG9, LH2, LH4

55 Silver Grey: 15, 18, 20, 40, 72, 73, 85, 86, 92, 148, 162, 168, 294, 471, CGD, LB5, LB8, LB9, LD3, LE6, LF5, LG2, LG6, LH7, LH9, WGD

49 Beige: 47, 63, 76, 101, 113, 132, 149, 167, 284, 287, 548, 725, BRD, CPD, LA7, LB1, LD6

75 Lemon: 70, LB7, LF7, LJ4

85 Burgundy Insert contrasts with color 60



NSC Certified



VINYL TREADS FOR THE VISUALLY IMPAIRED



Heavy Duty Square Nose (HD)



Heavy Duty Square Nose Visually Impaired (VIHD)



Safe-T-Rib® Square Nose (HT)



Safe-T-Rib Square Nose Visually Impaired (VIHT)



Safe-T-Rib Round Nose (HT)



Safe-T-Rib Round Nose Visually Impaired (VIHT)



Service Weight Square Nose (ST)

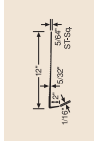

Safe-T-Grip Square Nose Visually Impaired (VIVG)





Service Weight
Round Nose
(ST)

A **W**



SAFE-T-RIB® (HT)



HEAVY DUTY (HD)



SERVICE WEIGHT (ST)

COLOR PALETTE AVAILABILITY

A = Color palette A
See pages 26-27 for details.

STAIR TREAD INSERT COLOR COMBINATIONS

- +** = See chart on page 20 for recommended contrasting color combinations.
- x** = See chart on page 20 for recommended contrasting color combinations.

SIZES / AVAILABLE LENGTHS

W = 3', 3.5', 4', 6', 8', 12'



VISUALLY IMPAIRED COLOR SOLUTIONS

GRIT TAPE COLOR +

Black



Brown



Grey



Tan



Yellow



White

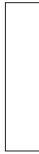
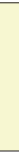

Photo-



luminescent

Black Grit Tape contrasts with colors 01, 21, 24, 28, 29, 31, 32, 38, 48, 55, 58, 71, 129, 150

Brown Grit Tape contrasts with colors 09, 11, 22, 34, 42, 45, 49, 80, 130

Grey Grit Tape contrasts with colors 18, 20, 40, 85, 86, 92

Tan Grit Tape contrasts with colors 44, 47, 63, 76, 132, 167, 283

Yellow Grit Tape available by special order

White Grit Tape available by special order

Photoluminescent Tape Insert available

CO-EXTRUDED VINYL INSERT



40

Black



47

Brown



49

Beige



55

Silver Grey



Photo-

luminescent



40 Black Insert contrasts with colors 01, 21, 24, 28, 29, 31, 32, 38, 48, 55, 58, 59, 71, 129, 150

47 Brown Insert contrasts with colors 09, 11, 22, 34, 42, 45, 49, 80, 130

49 Beige Insert contrasts with colors 44, 47, 63, 76, 132, 167, 283

55 Silver Grey Insert contrasts with colors 18, 20, 40, 85, 86, 92

Photoluminescent

Yellow or white co-extruded insert available by special order

RUBBER LANDING TILE FOR USE WITH VINYL STAIR TREADS



Tiles available in 24" x 24"
and in 12" x 12".

A **B**



Smooth (C)

All tile textures can be used as landing tile.

COLOR PALETTE AVAILABILITY

- A** = Color palette A
See pages 26-27 for details.
- B** = Color palette B.
See pages 28-31 for details.
- ▲** = Can be specially ordered in Prima
Marbleized and Prima Olivo colorways.
Visit tarketna.com. Minimums may apply.

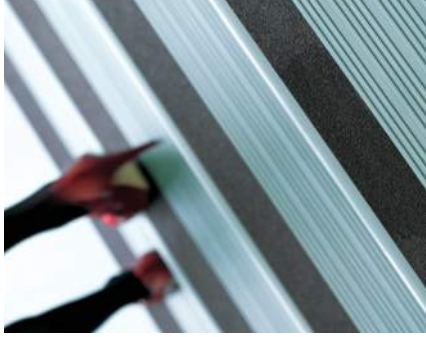

RUBBER STRINGERS AND RISERS

ITEM	SIZE	GAUGE
Stringers Solid Color	10" x 6'	.080"
Stringers Marbleized	10" x 6'	1/8"
Risers	6" x 4'	1/8"
	6" x 100'*	1/8"
	7" x 4'	1/8"
	7" x 5'	1/8"
	7" x 6'	1/8"
	7" x 50'*	1/8"



Stringers and risers are available in Color Palettes A and B. Speckled, Prima® Marbleized and Olio® are available by special order.

*Not available in Speckled or Marbleized.

TACTILE WARNING SURFACE A

Reduce potential accidents by alerting the visually impaired that they're approaching hazardous areas. Detectable tactile warning surface meets ANSI A117.1-1986 design requirements and is available in 36 attractive solid colors. Permanently co-extruded contrasting striping can also be ordered.



Tactile Warning Surface shown above.

VINYL STRINGERS AND RISERS

ITEM	SIZE	GAUGE
Stringers	10" x 50'	.080"
Risers	6" x 4'	.080"
	6" x 120'	.080"
	7" x 4'	.080"
	7" x 50'	.080"

A

Vinyl stringers and risers are available to coordinate with vinyl or rubber treads in your choice of more than 30 colors including ColorMatch®.

COLOR PALETTE AVAILABILITY

- A** = Color palette A
See pages 26-27 for details.
- B** = Color palette B.
See pages 28-31 for details.
- ▲** = Can be specially ordered in Prima Marbleized and Prima Otio colorways.
Visit tarkettna.com. Minimums may apply.



FLEXIBLE VINYL STAIR NOSINGS FOR THE VISUALLY IMPAIRED

VIRC�-XX-B

A *✓✗

1/8" material w/lip or 3/16" w/o lip. 2" co-extruded visually impaired strip.

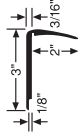

VIRC�-XX-B2

A +

1/8" material. 2" visually impaired grit tape insert.

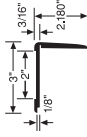

VITSN-XX

A ✗

Top set with 2" co-extruded visually impaired strip.

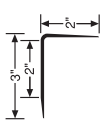

VIRC�-XX-A

A *✓✗

1/4" or 5/16" material. 2" co-extruded visually impaired strip.

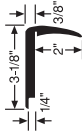

SOLID COLOR FLEXIBLE VINYL STAIR NOSINGS

VDL-XX-RD

A

1/8" material.

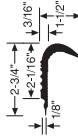

VDL-XX-SQ

A

1/8" material.

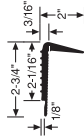

RCN-XX-B

A

1/8" material w/lip or 3/16" w/o lip.

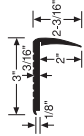

DTN-XX

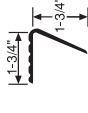

A

Top set stair nosing for residential use.

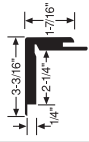

VIVCD-XX		1/4" or 5/16" material for step and riser. 2" co-extruded visually impaired strip.
A * ✓ ✗		

SLIM LINE STAIR NOSINGS

SLN-XX-A		1/4" materials on step to 1/4" material on riser.
A D		
SLN-XX-B		7/32" material on step to 1/4" material on riser
A D		
SLN-XX-C		3/8" material on step to 3/8" material on riser
A D		

- +** = See chart on page 20 for recommended contrasting color combinations.
- ✗** = See chart on page 20 for recommended contrasting color combinations.

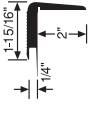
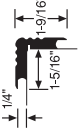
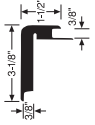
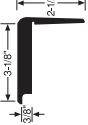
RCN-XX-A		1/4" or 5/16" material.
A *		
VCD-XX		1/4" or 5/16" material on step and riser.
A		
SVCD-XX-A		3/8" material on step and riser.
A		
SRCN-XX-C		3/8" material on step.
A		

COLOR PALETTE AVAILABILITY

- A** = Color palette A
See pages 26-27 for details.
- D** = Color palette D. See tarkettna.com for details.
- * = Also available in 50 White.
- ✓ = Available without contrasting strip.

Color Palette A

ColorMatch® is a designer palette of 36 leading colors that match Johnsonite's Rubber and Vinyl Specialty Flooring Products and Finishing Accessories.

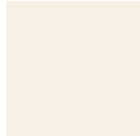

01 Snow White **W**

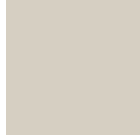

24 Grey Haze **WG**



55 Silver Grey **WG**



32 Pebble **WG**



29 Moon Rock **WG**



48 Grey **WG**

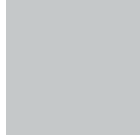

21 Platinum **CG**

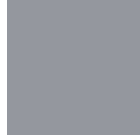

38 Pewter **CG**



28 Medium Grey **CG**



20 Charcoal **WG**



63 Burnt Umber **B**

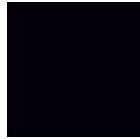

40 Black **B**



34 Almond **W**

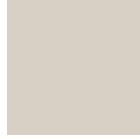

22 Pearl **CB**



31 Zephyr **CB**



80 Fawn **CB**



09 Clay **WB**



49 Beige **WB**



45 Sandalwood **WB**



283 Toast



129 Silk WB

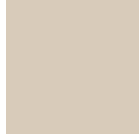

11 Canvas WB



42 Sable WB



76 Cinnamon



130 Sisal

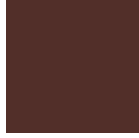

132 Espresso



85 Burgundy

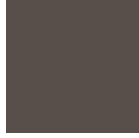

47 Brown



150 Wetlands



86 Hunter Green



167 Fudge



44 Dark Brown B



71 Storm Cloud CG



58 Windsor Blue



92 Blue Lagoon



18 Navy Blue

For your convenience, we've identified Color Foundations™ neutrals in the following way: WB (warm beige), CB (cool beige), WG (warm grey), CG (cool grey), B (black), W (white).

Color Palette B

28

Continued on pages 30 and 31.

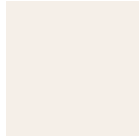

68 White Sand W



12 Hard Rock WB



121 Cement CB



280 Shoreline



469 Mystify CG



281 Grizzly WG



101 Seaweed



284 Ganache

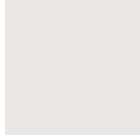

27 Mist WG



05 Stone WB



60 Taupe



33 Adobe Peach



282 Vaporize



474 Zen



190 Greege



168 Thunder



285 Morning WB
Light



286 Fortune WB
Cookie



19 Desert Camel



146 Butternut



473 Butterscotch



111 Honeycomb



112 Oakley



149 Milk Chocolate



TB5 Sunspot



75 Lemon



62 Tangerine Tango



148 Paprika



165 Squashed



287 Rustic



113 Chestnutty



166 Sienna



294 Big Top



TB6 Flame



163 Salsa



15 Cabernet

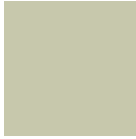

138 Celery



151 Iguana



475 Marshland



593 Duckweed



135 Chinese Jade



476 Parkway

For your convenience, we've identified Color Foundations™ neutrals in the following way: **WB** (warm beige), **CB** (cool beige), **WG** (warm grey), **CG** (cool grey), **B** (black), **W** (white).

Color Palette B

30



41 Sea Breeze



59 Heather Green



592 Seafoam



289 Jaded



471 Bok Choy



73 Palm Leaf



468 Gulfstream



291 Laguna



192 Tidewater



293 Peacock



591 Sleet



139 Glacier



590 Denim



84 Blue Jeans



470 Cerulean



106 Skinny Dip



70 Bluest



72 Harbour



472 Imperial



162 Sovereign

Metallurgy™ Colorways

Shown in Hammered Texture.

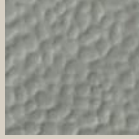

CGL Frosted
Diamond

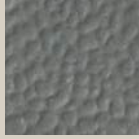

CGM Silver
Slate



CGD Black
Diamond



WGL Antique
Metal



WGM Dusty
Charm



WGD Smokey
Pearl



BRM Sugar
Cookie



BRM Cocoa
Cabana



BRD Mahogany
Glaze



AGM Venetian
Gold



CPM Vintage
Copper



CPD Chocolate
Frosting

For your convenience, we've identified Color Foundations™ neutrals in the following way: **WB** (warm beige), **CB** (cool beige), **WG** (warm grey), **CG** (cool grey), **B** (black), **W** (white).

MicroTone™ Speckled Colorways

32

Shown in Hammered Texture.
Continued on pages 34 and 35.



LF2 Wedding Cake



LF1 Cape May W



LE3 Silkworm WB



LE5 El Giza CB



LD8 Crumbcake



LJ1 Glazed Icing W



LA6 Antique Ivory WG



LB3 Sepia Tone WB



LB2 Great Plains WB

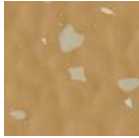

LA1 Peanut Brittle WB



LA3 Seaspray WG



LB4 Mottled Egg WG



LA9 Ceramic Glaze WB



LE1 Sandbox CB



LE2 Chocolate Cream WB

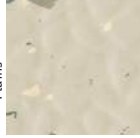

LJ7 Wayne Manor WG



LG7 Mystique CG

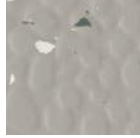

LC6 Nightowl WG

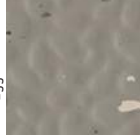

LC5 Riverbed WG

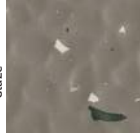

LD7 Lunar Explorer WG



LE4 Log Cabin CB



LD5 Williamsburg CG

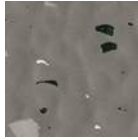

LC4 Mountaineer WG

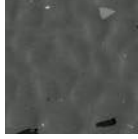

LB9 Rainstorm WG



LB1 Vanilla Bean



LD6 Cosmology B

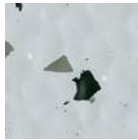

LC3 The Times CG

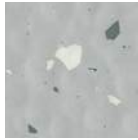

LC7 Best Seller CG



LC2 City Block CG



LC1 Smokininess CG

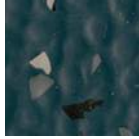

LB5 Nightfall

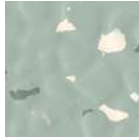

LH3 Harmony



LF6 Sherwood Forest



LD2 Backwoods



LJ2 Spring Valley



LB8 Vortex B

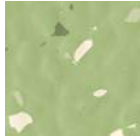

LH2 Savannah



LA4 Hudson Valley

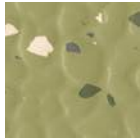

LH8 Toscana



LG9 Unfettered



LG8 Tuscan Olive



LE7 Chameleon

For your convenience, we've identified Color Foundations™ neutrals in the following way: **WB** (warm beige), **CB** (cool beige), **WG** (warm grey), **CG** (cool grey), **B** (black), **W** (white).

MicroTone™ Speckled Colorways

34

Shown in Hammered Texture.

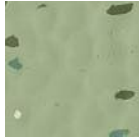

LC9 Dino



LF3 Dragonwyck

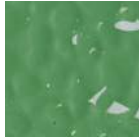

LF5 Irish Meadow



LE6 Emerald City



LD1 Rainshower

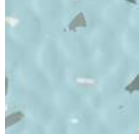

LC8 Melody



LF4 Cedar Grove

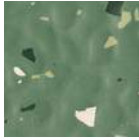

LH1 Herbal Remedy



LH9 Alpine

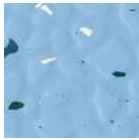

LF8 High Seas

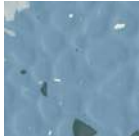

LG1 Freshaire



LF9 Caribbean Cruise



LA5 Chesapeake Bay



LJ3 Reflecting Pool

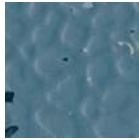

LD4 Rain Puddle



LB6 Quenched

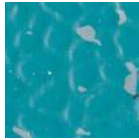

LD9 Peacock Plume



LJ5 Glacier Lake



LB7 Go Blue

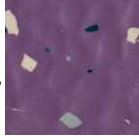

LJ4 Sugar Plum



LG3 Grape Tart



LA7 Dark Roast



LH6 Coffee Bean



LJ6 Cinnamon
Toast



LG4 Crunchbar



LF7 Blueberry Pie



LD3 Indigo Dye



LG2 Wizardry



LE8 French Toast



LK1 Red Caboose



LG5 Georgian Clay



LG6 Wine Cellar



LH5 Red River
Valley



LA2 Wedgewood



LJ8 Summerset



LH7 Sizzling



LA8 Banana
Republic



LJ9 High Energy



LH4 Penny Arcade



LE9 Tropical
Smoothie

For your convenience, we've identified Color Foundations™ neutrals in the following way: **WB** (warm beige), **CB** (cool beige), **WG** (warm grey), **CG** (cool grey), **B** (black), **W** (white).

RUBBER STAIR TREADS

Rubber Stair Treads and Tread/Riser Combinations are key elements of Johnsonite's Stairwell Solutions. Naturally slip resistant, rubber treads can help prevent costly stair fall accidents. They can also be specified with contrasting inserts for the visually impaired to maximize safety benefits. Just one part of an integrated system, rubber stair treads and tread/risers can be coordinated with matching stringers and landing tile to create a safer, more aesthetically appealing stairwell solution. You can also combine rubber and vinyl stairwell components with complete confidence, without concerns about color variation.

TECHNICAL DATA	STANDARDS	RUBBER STAIR TREADS
Type	ASTM F 2169	Resilient Stair Treads
Classification	ASTM F 2169	Type TS, Class 1 and 2, Group 1 and 2
Resistance to Heat	ASTM F 1514	$\Delta\Sigma \leq 8.0$
Resistance to Light	ASTM F 1515	$\Delta\Sigma \leq 8.0$
Hardness	ASTM D 2240	Min 85 Shore A
Slip Resistance	ASTM D 2047	SCOF ≥ 0.8
Flame Resistance	ASTM E 648	Class 1

Smoke Density	ASTM E 662	< 450
Chemical Resistance	ASTM F 925	Good
Size		3' to 9' wide
Colorways		More than 200
Surface Textures		9

Please visit tarkettna.com for the most updated specifications, installation, cleaning and maintenance instructions.

HOW TO ORDER:

Product Code – Color Number – Length – Nose Style (Example: HTR – 47 – 6' – SQ)



VINYL STAIR TREADS

Vinyl Stair Treads are key elements of Johnsonite's Stairwell Solutions. When combined with contrasting inserts, vinyl treads satisfy California Title 24 requirements, ADA Recommendations for the Visually Impaired and commercial requirements for slip resistance. As part of an integrated system, vinyl treads can be coordinated with stringers and landing tiles for a cohesive look. Vinyl and rubber stairwell components can also be combined with confidence, without concerns about variations in color.

TECHNICAL DATA	STANDARDS	VINYL STAIR TREADS
Type of Floor Covering	ASTM F 2169	Resilient Stair Treads
Classification	ASTM F 2169	Type TV, Class 2, Group 1 & 2
Heat Resistance by Color Change	ASTM F 1514	$\Delta\Sigma \leq 8.0$
Light Resistance by Color Change	ASTM F 1515	$\Delta\Sigma \leq 8.0$
Hardness	ASTM D 2240	Min 85 Shore A
Slip Resistance	ASTM D 2047	SCOF ≥ 0.5
Flame Resistance	ASTM E 648	Class 1
Smoke Density	ASTM E 662	≤ 450

Chemical Resistance	ASTM F 925	Good
Size		3' to 12' Wide
Colors		36
Styles		5

Please visit tarkettna.com for the most updated specifications, installation, cleaning and maintenance instructions.

HOW TO ORDER:

Product Code – Color Number – Length – Nose Type (Example: VIHD – 18 – 4' SQ Navy Blue)
 (Example: S/B VIHD – 18 – 4' SQ)



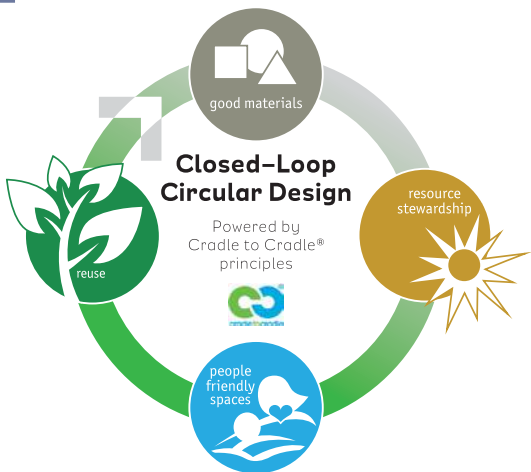

The Johnsonite system features coordinating accessories, including transitions, finishing borders (wall base) and corner guards to complete your flooring design and installation.

For samples or information on Johnsonite's full line of flooring and finishing accessories, please visit tarkettna.com or contact the sample department at 800.899.8916.